

Bistabiler Magnetriegel

1 2 3 4 5 6 7 8 9 10

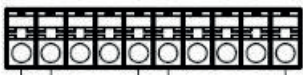

Mod 0

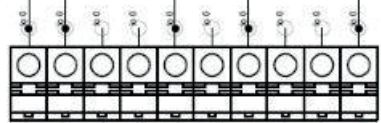
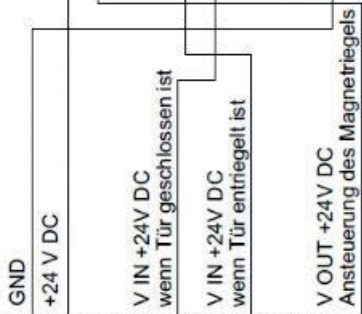

Mod 7

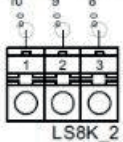
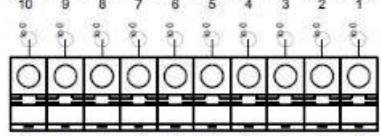
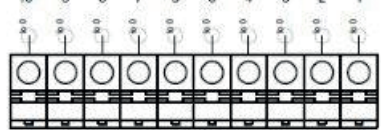

LS8K_2

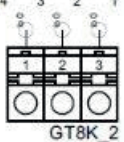

GT8K_2

GTS Steuerung SKA-AGx-...